

T036ZMP930DAPW | RAY 75 ZOOM

Professional adjustable LED projector with a variable light beam opening

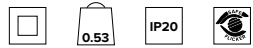

The fixture's photometric values can be found on the following pages

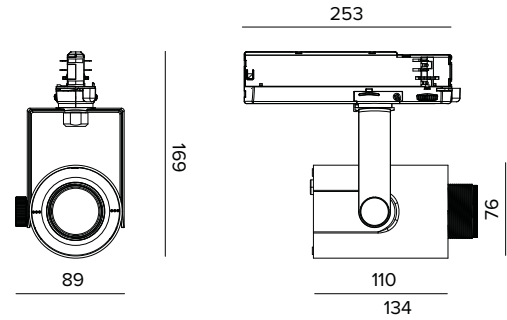

The figures on the drawing are expressed in mm.

SOURCE

High efficiency Chip on Board LED Ra90. Ra97 on request.

Energy efficiency class: F

Nominal power: 17W

Nominal flux: 1759lm

Colour rendering index: 90

Rf: 92

Rg: 101

CCT nominal: 3000K

Lifetime (L80/B10): >50000h tq +25°C

ILLUMINOTECHNICAL CHARACTERISTICS

ZOOM PRECISION version: a classic system with the lens at a variable distance from the source. Telescopic optics holders in black anti-reflective anodised aluminium. Plano convex lens in optical glass, highly reflective anodised aluminium reflector, PMMA front diffusor.

Optic: HYBRID

Beam angles: NSP-WFL

Optical efficiency: See photometries

Fixture flux: See photometries

Luminous efficacy: See photometries

Photobiological safety: Compliant with RG1 low risk group

MECHANICAL CHARACTERISTICS

Painted die-cast aluminium body. Black painted polycarbonate front ring. Adjustable from 0° to -90° on the vertical plane and 359° on the horizontal plane. Mechanical beam locking system on the vertical plane and friction beam locking system on the horizontal plane. The centre of gravity always remains in axis with the track regardless of the aiming.

Colour and finish: Plaster white

Dimensions: 75

Weight: 0.53Kg

Version: ZOOM PRECISION

Degree of protection: IP20

ELECTRICAL CHARACTERISTICS

DALI electronic driver integrated into the track adapter.

Fixture Power: 20W

Power supply: 220-240Vac 50/60Hz

Insulation Class: CLASS 2

Type of driver / Control: DALI

Driver included: YES

Class F: YES

SAFE FLICKER: PstLM=<1 and SVM=<0.4 (IEC TR 61547-1 and IEC TR 63158), to ensure a more comfortable and safe light

Ambient temperature: 0°C / +25°C

INSTALLATION

Electrified track mounting.

NOTES

110-277Vac version available on request.

WARRANTY

5 years.

WARNING

Luminaire designed for disposal/recycling at end-of-life. Replaceable (LED only) light source by a professional. Replaceable control gear by a professional.

Due to the technological evolution of the electronic components, the data provided may be updated, and as such, confirmation must be requested during the order process.

Luminous flux and power supply have +/-10% tolerances with respect to the indicated value. tq +25°C (CIE 121).

We reserve the right to make technical changes.

Targetti Sankey S.r.l.
Via Pratese, 164
50145 Firenze - Italy
Tel: +39 055 37911
targetti.com
targetti@targetti.com

CCIAA Firenze
Share Capital:
€ 500.000,00
VAT N. (IT):
01537660480
R.E.A: FI-275656

TARGETTI

T036ZMP930DAPW | RAY 75 ZOOM

Professional adjustable LED projector with a variable light beam opening

		3000K	H(m)	D(m)	Emax(lx)	
		Ra90		9°		
Fixture Power	20W	1	0.16	12492		
Source Flux	1759lm	2	0.32	3123		
Fixture Flux	404lm	3	0.47	1388		
Efficacy	21lm/W	4	0.63	781		
TS1947	I _{max} =7102cd/klm	I _{max}	12492cd	5	0.79	500

		3000K	H(m)	D(m)	Emax(lx)	
		Ra90		64°		
Fixture Power	20W	1	1.24	1212		
Source Flux	1759lm	2	2.48	303		
Fixture Flux	1253lm	3	3.73	135		
Efficacy	64lm/W	4	4.97	76		
TS1946	I _{max} =699cd/klm	I _{max}	1230cd	5	6.21	48

NSP

Fixture flux	404lm
Luminous efficacy	21lm/W
Optical efficiency	23%

WFL

Fixture flux	1253lm
Luminous efficacy	64lm/W
Optical efficiency	71%

Due to the technological evolution of the electronic components, the data provided may be updated, and as such, confirmation must be requested during the order process.

Luminous flux and power supply have +/-10% tolerances with respect to the indicated value. tq +25°C (CIE 121).

We reserve the right to make technical changes.

Targetti Sankey S.r.l.
Via Pratese, 164
50145 Firenze - Italy
Tel: +39 055 37911
targetti.com
targetti@targetti.com

CCIAA Firenze
Share Capital:
€ 500.000,00
VAT N. (IT):
01537660480
R.E.A.: FI-275656

TARGETTI